

# GS100 Tech Sheet

## Balboa Water Group System PN 56300

System Model # MP7-GS100-DCA-3.0K

Software Version # 41

EPN # 3825

Base PCBA - PN 56301

PCB VS100C - PN 24084 Rev A

### Base Panels

VL200 (Mini) – PN 55123

VL240 (MVP240) – PN 55080

VL260 (MVP260) – PN 55081

VL401 (LCD Lite Duplex) – PN 54665

VL403 (LED Lite Duplex) – PN 54664



# Basic System Features and Functions

## **Power Requirements**

- 230VAC, 1~, 16A, 50Hz
- 3 wires (line, neutral, ground)

## **System Outputs**

### **Setup 1 (As Manufactured)**

- 230V Pump 1, 2-Speed
- 230V Ozone
- 10V Spa Light
- 230V 3.0kW Heater  
PN 58202

# Basic System Features and Functions

Any time you change a DIP Switch, other than A1, you must reset Persistent Memory for your new DIP Switch Settings changes to take effect. If you do not reset Persistent Memory, your system may function improperly.

## To reset Persistent Memory:

- Power down by disconnecting power source from spa.
- Put a jumper across J43, covering both pins. (See illustration below)
- Power up by connecting power source to spa.
- Wait until “P” is displayed on your panel.
- Power down again.
- Remove jumper from J43 (May also move to cover 1 pin only)
- Power up again.

## About Persistent Memory and Time of Day Retention:

This system uses memory that doesn't require a battery to store a variety of settings. What we refer to as Persistent Memory stores the filter settings, the set temperature, and the heat mode.

Persistent Memory is not used for Time of Day. Only models with a Serial Deluxe panel installed (VS5xxDZ and GS5xxDZ) can display the time. However, during power loss to the spa, the system will lose the correct time, and reset to 12:00 PM when power is restored.

## Power Up Display Sequence

Upon power up, you should see the following on the display:

- Three numbers in a row, which are the SSID (the System Software ID). The third display of these numbers is the Software Version, which should match the version of your system. For example, if these three numbers are 100 67 38, that is a VS511SZ at version 38.
- Displayed next is: “24” (indicating the system is configured for a heater between 3 and 6 kW) or “12” (indicating the system is configured for a heater effectively\* between 1 and 3 kW). “24” should appear for all VS models running at 240VAC. “12” should appear for all VS models running at 120VAC, as well as all GS models. (\*A heater which is rated at 4 kW at 240VAC will function as a 1 kW heater at 120VAC.)
- “P” will appear to signal the start of Priming Mode.

At this point, the power up sequence is complete. Refer to the Reference Card for the VS or GS System model of your spa for information about how the spa operates from this point on, including how to adjust the Time of Day if using a Serial Deluxe style panel.

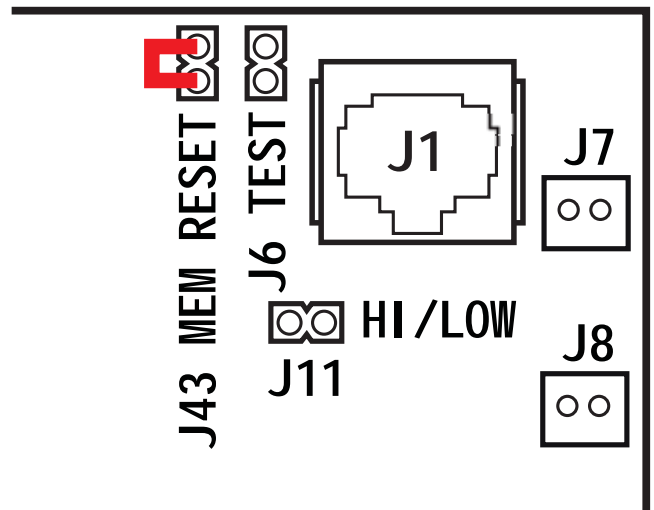

# Wiring Configuration and DIP Settings

## Setup 1 (As Manufactured)

- 230V Pump 1, 2-Speed
- 10V Spa Light
- 230V Ozone (with Pump 1 Low)
- 3.0kW @ 230VAC Heater
- VL401 Main Panel



GS100  
12-10-12

PN 56300

OFF POSITION	DIP SWITCH #	ON POSITION
TEST MODE OFF*	1	TEST MODE ON*
UNUSED, P1, TEMP, LIGHT	2	P1, LT, TEMP DOWN, TEMP UP
DUPLEX PANEL	3	MINI PANEL
N/A MUST BE OFF	4	N/A MUST BE OFF
SEE PUMP TABLE	5	SEE PUMP TABLE
60HZ OPERATION	6	50HZ OPERATION
STD, ECON, SLEEP ALLOWED	7	STANDARD MODE ONLY
DEGREES FAHRENHEIT	8	DEGREES CELSIUS
SEE PUMP TABLE	9	SEE PUMP TABLE
HIGH AMP - HEAT W/P1 HI	10	LOW AMP - NO HEAT W/P1 HI

\*SWITCH 1 IS NORMALLY OFF ALL UNUSED SWITCHES SHOULD BE OFF

SWITCH 5	SWITCH 9	LOW SPEED	HIGH SPEED
OFF	OFF	2 HOURS	15 MINUTES
ON	OFF	2 HOURS	30 MINUTES
OFF	ON	15 MINUTES	15 MINUTES
ON	ON	30 MINUTES	30 MINUTES

LOCATION	DEVICE
J23	NETZSTROMVERSORGUNG 2-GESCHW. -PUMPE 1 ALIMENTATION POMPE 1 A 2 VITESSES 2-SPEED PUMP 1
J29	OZONGENERATOR GENERATOROZONE OZONE GENERATOR
J20	BELEUCHTUNG ECLAIRAGE BAIN HYDRO SPA LIGHT

TORQUE RANGE FOR MAIN TERMINAL BLOCK (TB1):  
27-30 IN. LBS.  
(31.1-34.5 kg cm)

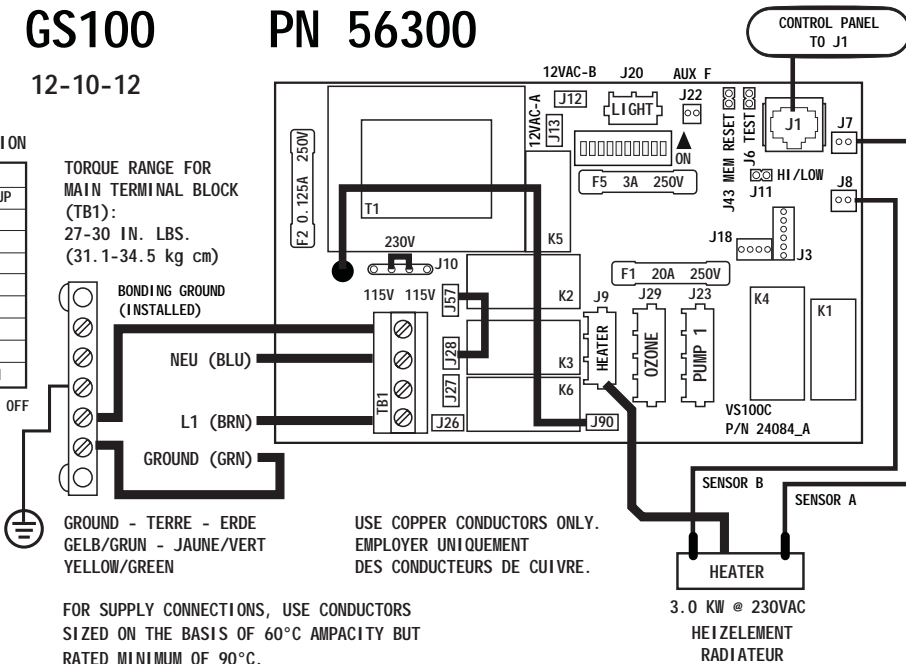

**WARNING:** Main Power to system should be turned OFF BEFORE adjusting DIP switches.  
**WARNING:** Persistent Memory (J43) must be RESET to allow new DIP switch settings to take effect. (See Persistent Memory page)

Panel Button Assignments  
1= Pump 1      3= Temp Down  
2= Light      4= Temp Up

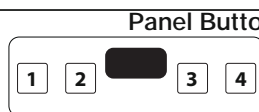

### Board Connector Key

- 1 Typically Line voltage
  - 2 Typically Line voltage for 2-speed pumps
  - 3 Neutral (Common)
  - 4 Ground
- Note flat sides in connector

# DIP Switches and Jumpers Definitions

## SSID 100 59 41

## Base Model VS100

### DIP Switch Key



- A1 Test Mode (normally OFF)
- A2 "ON" position: Button layout will be: Pump 1, Light, Temp Down, Temp Up \*  
"OFF" position: Button layout will be: Unused, Pump 1, Temp, Light
- A3 "ON" position: use Mini Panel \*   
"OFF" position: use Lite Duplex or Digital Duplex panel  
- A4 N/A (must be OFF)
- A5 Pump 1 timeout, see Table 1
- A6 "ON" position: 50Hz operation  
"OFF" position: 60Hz operation
- A7 "ON" position: Standard mode only  
"OFF" position: Std/Ecn/Sleep mode changes allowed
- A8 "ON" position: temperature is displayed in degrees Celsius  
"OFF" position: temperature is displayed in degrees Fahrenheit
- A9 Pump 1 timeout, see Table 1
- A10 "ON" position: heater is disabled while the high-speed pump is running (low amperage mode)  
"OFF" position: heater can run while the high-speed pump is running (high amperage mode)

Table 1		Pump 1 Timeouts	
A5	A9	Low-spd	Hi-spd
OFF	OFF	2 hours	15 min
ON	OFF	2 hours	30 min
OFF	ON	15 min	15 min
ON	ON	30 min	30 min

\* Panels with button layout  are not compatible when A2 or A3 is ON.  
Note: No blower or second pump available.

### Jumper Key

- J43** When jumper is placed on 2 pins during power-up, system will reset persistent memory.  
Leave on 1 pin only to enable persistent memory feature.

### WARNING:

- Setting DIP switches incorrectly may cause abnormal system behavior and/or damage to system components.
- Refer to Switchbank illustration on Wiring Configuration page for correct settings for this system.
- Contact Balboa if you require additional configuration pages added to this tech sheet.

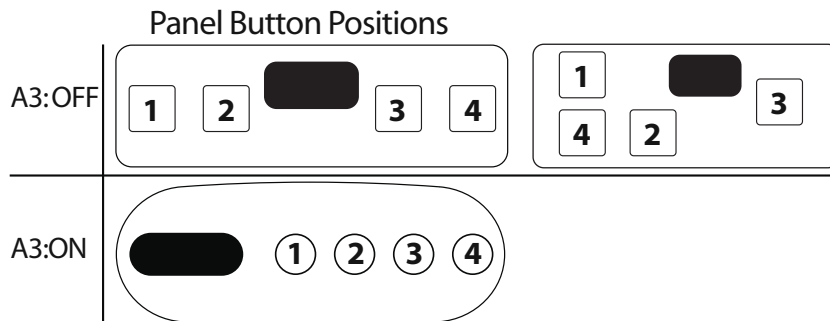

**Panel Button Assignments**

A2:OFF	1=Unused 2=Pump 1	3=Temp 4=Light
A2:ON	1=Pump 1 2=Light	3=Temp Down 4=Temp Up

# Ozone Connections

**Ozone Connector Voltage:** The VS100 circuit board is factory configured to deliver a preset voltage of 120V to the on-board ozone connector (J29).

**Balboa Ozone Generator:** The board is set up to operate a 120V ozone generator; the connector on the ozone generator is likely to be configured correctly, but should be compared to the illustration below.

*Note: A special tool is required to remove the pins from the connector body once they are snapped in place. Check with your Balboa Account Manager for information on purchasing a pin-removal tool.*

## Balboa Ozone connector configuration for 230VAC 50Hz:

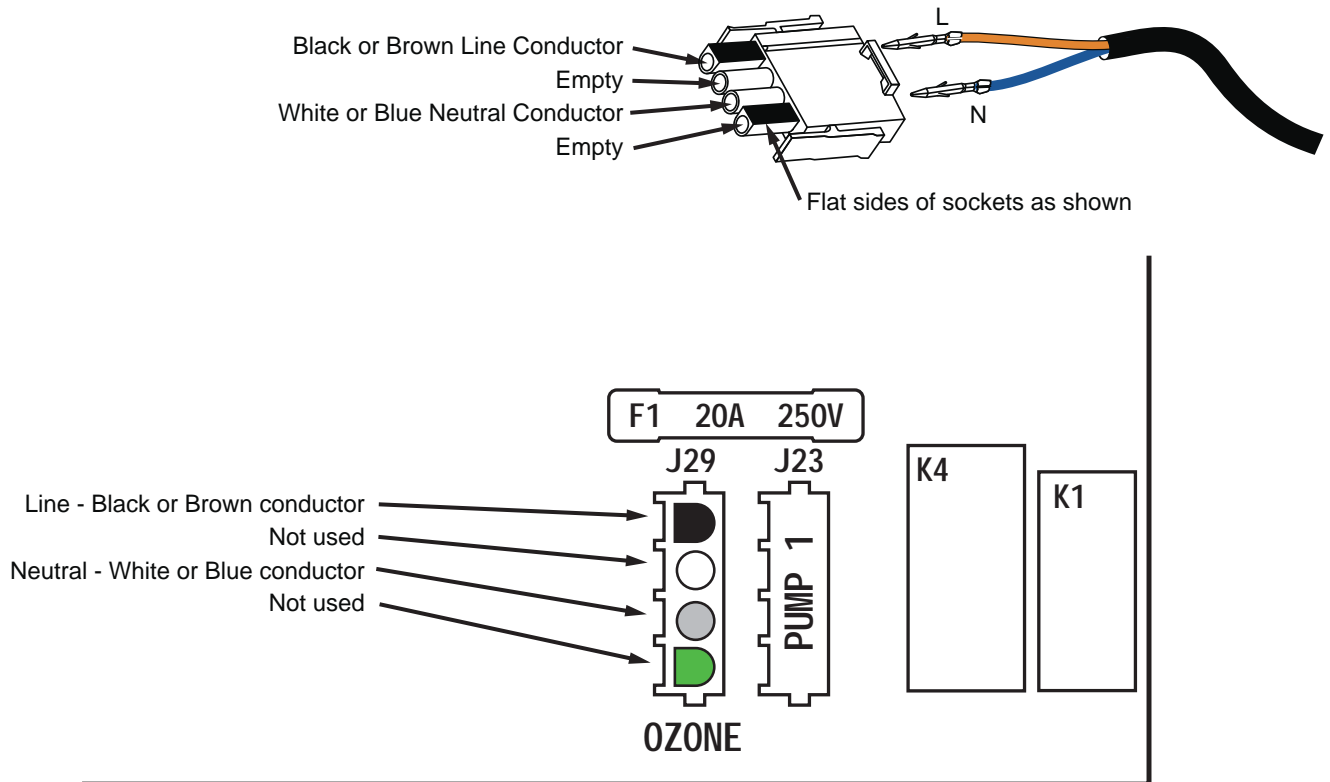

# Duplex Panel Configurations

**SETUP (As MANUFACTURED)**



VL403 (Lite Digital)  
 PN 54664 with Overlay PN 11884  
 • Connects to Main Panel terminal J1



VL401 (Lite Digital)  
 PN 54665 with Overlay PN 11885  
 • Connects to Main Panel terminal J1

## Switchbank

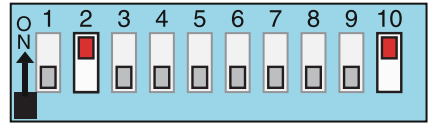

DIP switch A3 must be OFF



VL200 (Mini Panel)  
 PN 55123 with Overlay PN 11852  
 • Connects to Main Panel terminal J1

## Switchbank

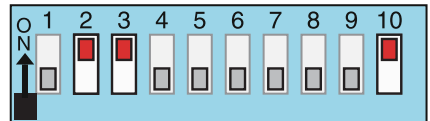

DIP switch A3 must be ON



VL240 (MVP240)  
 PN 55080 with Overlay PN 11745  
 • Connects to Main Panel terminal J1



VL260 (MVP260)  
 PN 55081 with Overlay PN 11746  
 • Connects to Main Panel terminal J1

**OPTIONAL PANELS**